

The logo for Spaceright Europe Ltd is a stylized circular emblem composed of several segments in shades of grey and blue, with a prominent orange segment at the top. The text 'SPACERIGHT' is written in a bold, sans-serif font, with 'SPACER' in orange and 'RIGHT' in grey. Below it, 'europe ltd' is written in a smaller, lowercase, grey font.

SPACERIGHT
europe ltd



Dining Furniture

2020

In designing our range, we have used our expert knowledge of schools and similar environments, to deliver a comprehensive range of dining solutions, which represent the very best in quality, versatility and value.



Innovation, quality, service and design are at the forefront of everything we do and drive the continuing success of our business.

- **Innovation**

As the leading manufacturer in our field, we are dedicated to investing in new product development and technological efficiencies, to enable us to successfully deliver cutting edge solutions for our customers.

- **Quality**

We are committed to using the best quality materials and most skilled craftsmen to ensure we supply products which are manufactured to a high standard, making them durable, safe and reliable, whilst also representing excellent value.

- **Service**

Customer service is pivotal to our success and we strive to provide the very best expert advice, helpful product information and after sales support, as well as competitive pricing, quick lead times and a reliable delivery service.

- **Design**

Our history goes back over 100 years, meaning that our product knowledge and market insight is unparalleled, so when it comes to designing products and space planning, we are experts in our field.

Free 3D Space Planning

We offer a completely free and comprehensive site survey and space planning service for our dining furniture range. So whether you have a detailed vision of what you want or need inspiration, we can provide a solution which is right for you.



Dining Furniture

8 Seat Primo Round Mobile Folding Table

- Contemporary dining table with gloss or oak effect table top
- Designed for use in secondary, higher and further education establishments
- 50mm thick laminated table top and grey frame
- Fits through standard height doorway (1980mm) for storage and transportation
- Open position safety lock (to ensure table does not revert to folding position)
- Easy-clean intermediate lock for improved hygiene
- Transport and storage locking positions
- 3 seat options to choose from
- Adult height 767mm
- Heavy duty locking castors
- 3 modern table top options to choose from
- 16 year warranty on welds and mechanism



Watch the video

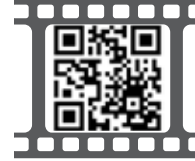

Scan the QR code



NEW

Moderno Oak Primo Mobile Folding Table

767(h) x 2155mm (d)	Stool
767(h) x 2155mm (d)	Seat
767(h) x 2155mm (d)	Full Back

NEW

White Gloss Primo Mobile Folding Table

767(h) x 2155mm (d)	Stool
767(h) x 2155mm (d)	Seat
767(h) x 2155mm (d)	Full Back

NEW

Black Gloss Primo Mobile Folding Table

767(h) x 2155mm (d)	Stool
767(h) x 2155mm (d)	Seat
767(h) x 2155mm (d)	Full Back

Colour Options



Primo Folding Round

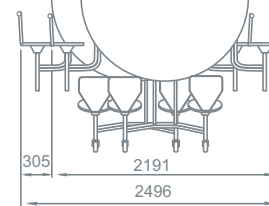
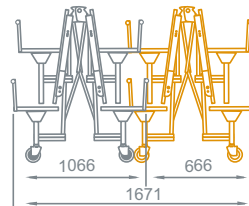
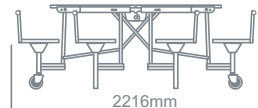
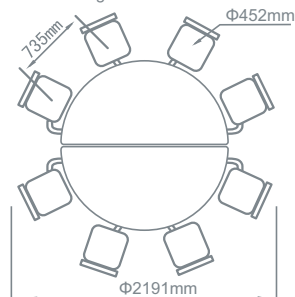

	29
A	767mm
B	425mm
C	1380mm

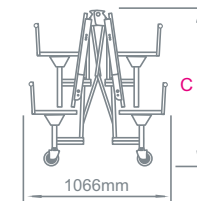
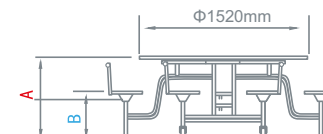

Contemporary

Primo tables combine all the key features of our standard mobile tables with a contemporary style which is ideal for secondary, higher and further education establishments.

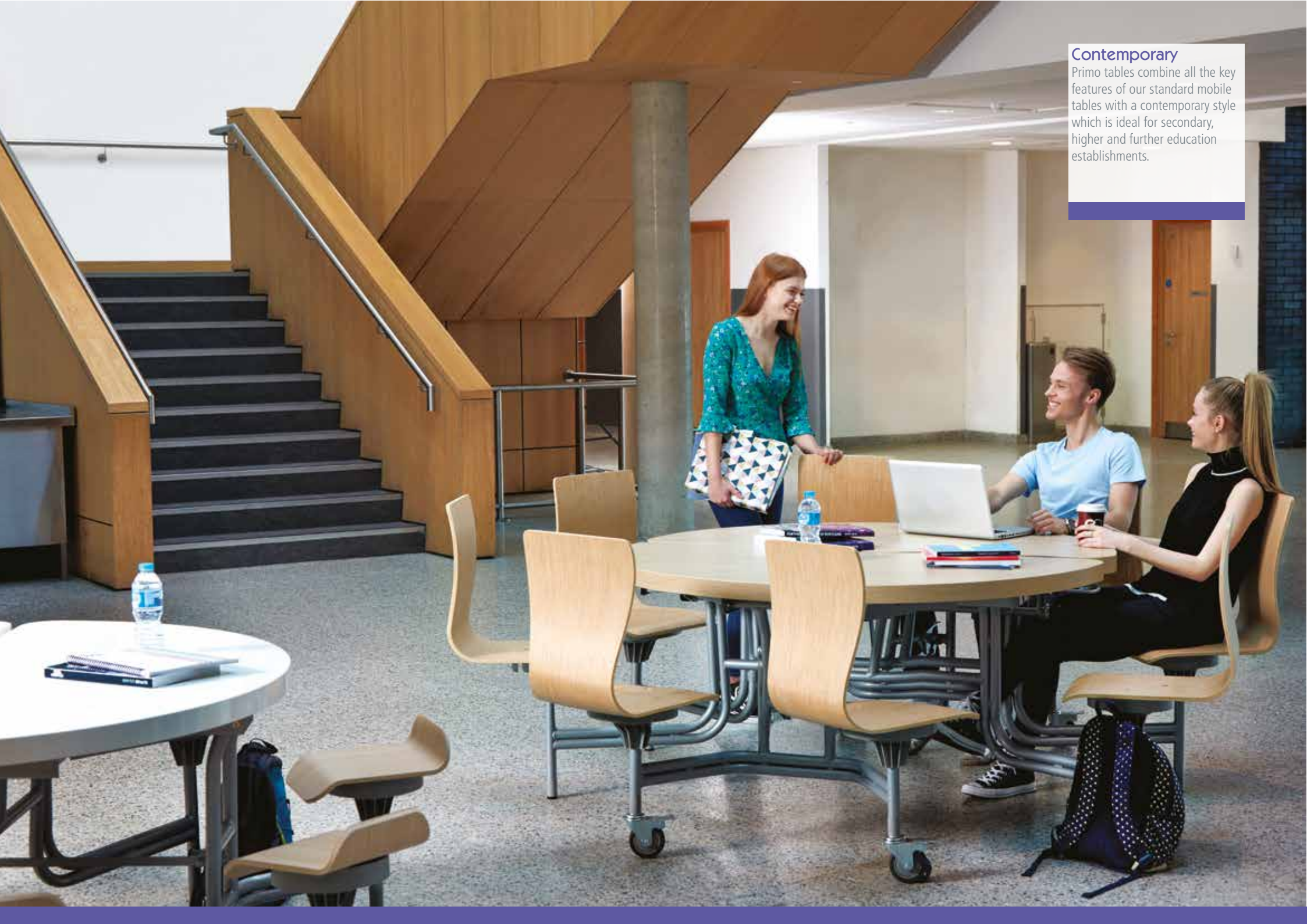

Dining Furniture

12 Seat Primo Rectangular Mobile Folding Table

- Contemporary dining table with gloss or oak effect table top
- Designed for use in secondary, higher and further education establishments
- 50mm thick laminated table top and grey frame
- Fits through standard height doorway (1980mm) for storage and transportation
- Open position safety lock (to ensure table does not revert to folding position)
- Easy-clean intermediate lock for improved hygiene
- Transport and storage locking positions
- 3 seat options to choose from
- Adult height 767mm
- Heavy duty locking castors
- 3 modern table top options to choose from
- 16 year warranty on welds and mechanism

Watch the video

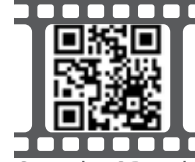

Scan the QR code



Seat Option



Stool Option



Full Back Option



Moderno Oak Primo Mobile Folding Table

767(h) x 3080(w) x 1500mm (d)	Stool
767(h) x 3080(w) x 1500mm (d)	Seat
767(h) x 3080(w) x 1500mm (d)	Full Back



White Gloss Primo Mobile Folding Table

767(h) x 3080(w) x 1500mm (d)	Stool
767(h) x 3080(w) x 1500mm (d)	Seat
767(h) x 3080(w) x 1500mm (d)	Full Back



Black Gloss Primo Mobile Folding Table

767(h) x 3080(w) x 1500mm (d)	Stool
767(h) x 3080(w) x 1500mm (d)	Seat
767(h) x 3080(w) x 1500mm (d)	Full Back

Colour Options



White Gloss



Black Gloss



Moderno Oak



Model Rectangular 1012 Primo Table

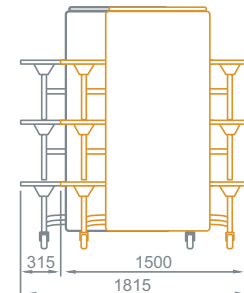
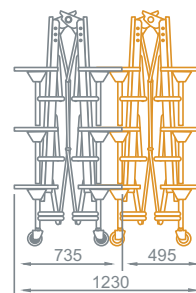
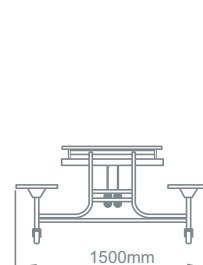
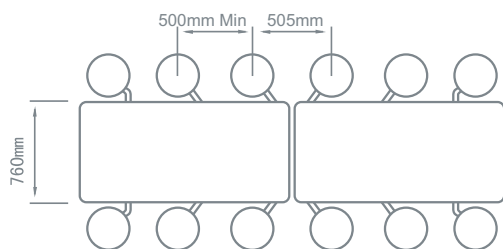

	10.12.30
A	767mm
B	435mm
C	1860mm
D	750mm

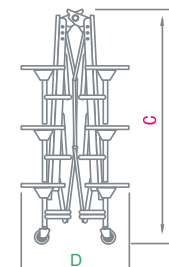
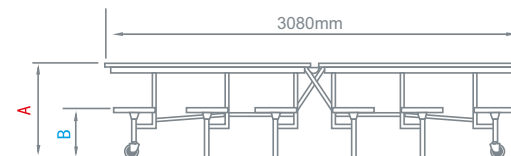



Comfort

With three seat options to choose from, the Primo table combines stylish design with both flexibility and comfort. A fresh, modern solution for canteens and dining halls.

Dining Furniture

8 Seat Round and Octagonal Mobile Folding Tables

- Mobile folding table with grey frame which is easy to fold, store and clean
- Laminated table top with tough edging and MDF core (water resistant and easy clean)
- Fits through standard height doorway (1980mm) for storage and transportation
- Open position safety lock (to ensure table does not revert to folding position)
- Easy-clean intermediate lock for improved hygiene
- Choice of two heights (primary and secondary)
- 16 year warranty on welds and mechanism
- Heavy duty locking castors
- 3 table top colours to choose from
- 11 stool colours to choose from
- FIRA certified



Round Mobile Folding Table (8 Seat Unit)

685(h) x 2155mm (d)

735(h) x 2155mm (d)



Octagonal Mobile Folding Table (8 Seat Unit)

685(h) x 2155mm (d)

735(h) x 2155mm (d)

Table Top Colour Options * New colours available from January 2020

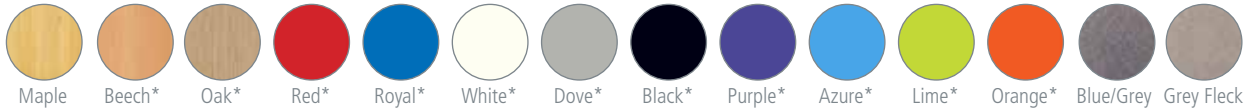

Stool Colour Options

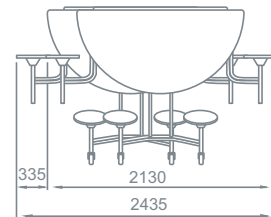
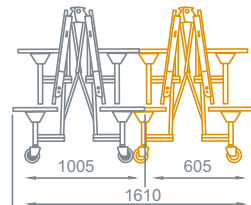
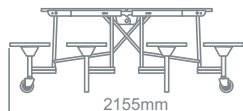
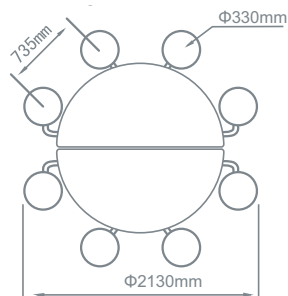

	27	29
A	685mm	735mm
B	375mm	425mm
C	1330mm	1380mm

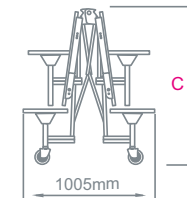
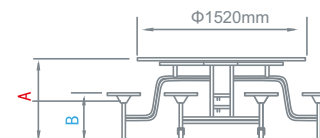



Effortless

Our mobile folding tables make it quick and effortless to convert multi-use halls into dining areas without the need for heavy lifting. A perfect solution for busy schools and canteens.

Dining Furniture

8 Seat Rectangular Mobile Folding Table

- Mobile folding table with grey frame which is easy to fold, store and clean
- Laminated table top with tough edging and MDF core (water resistant and easy clean)
- Fits through standard height doorway (1980mm) for storage and transportation
- Open position safety lock (to ensure table does not revert to folding position)
- Easy-clean intermediate lock for improved hygiene
- Transport and storage locking positions
- Choice of two heights (primary and secondary)
- 16 year warranty on welds and mechanism
- Heavy duty locking castors
- 3 table top colours to choose from
- 11 stool colours to choose from
- FIRA certified



Rectangular Mobile Folding Table (8 Seat Unit)

685(h) x 2380(w) x 1500mm (d)

735(h) x 2380(w) x 1500mm (d)

Table Top Colour Options * New colours available from January 2020

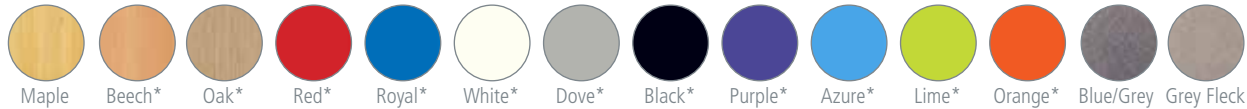

Stool Colour Options



Model Rectangular 808

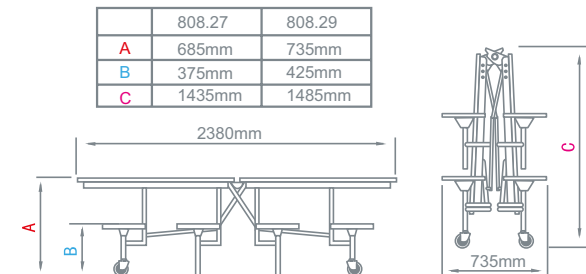
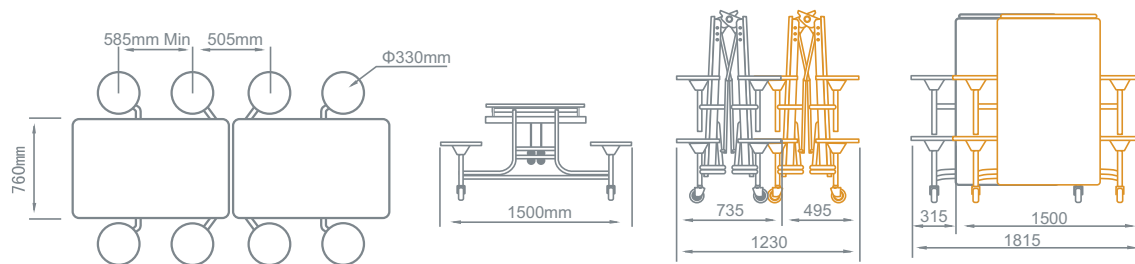



Hygienic

Safety and cleanliness are important factors in the design of our mobile folding tables. Each has an open position safety lock to ensure the table does not revert to the folding position and an intermediate lock for improved hygiene.

Dining Furniture

12 Seat Rectangular Mobile Folding Table

- Mobile folding table with grey frame which is easy to fold, store and clean
- Laminated table top with tough edging and MDF core (water resistant and easy clean)
- Fits through standard height doorway (1980mm) for storage and transportation
- Open position safety lock (to ensure table does not revert to folding position)
- Easy-clean intermediate lock for improved hygiene
- Transport and storage locking positions
- Choice of two heights (primary and secondary)
- 16 year warranty on welds and mechanism
- Heavy duty locking castors
- 3 table top colours to choose from
- 11 stool colours to choose from
- FIRA certified



Rectangular Mobile Folding Table (12 Seat Unit)

685(h) x 3080(w) x 1500mm (d)

735(h) x 3080(w) x 1500mm (d)

Table Top Colour Options * New colours available from January 2020

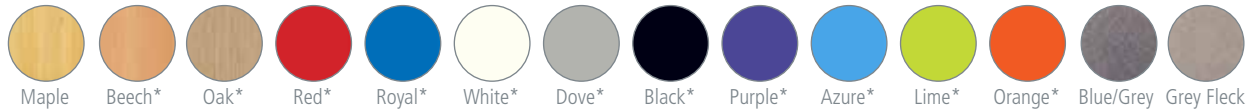

Stool Colour Options



Model Rectangular 1012

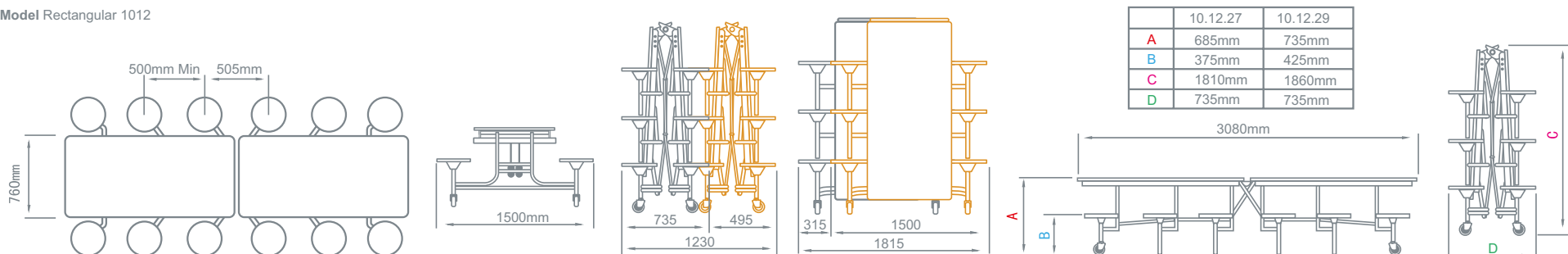

Popular

The twelve seat dining unit is the most popular configuration amongst schools with three table top colours to choose from and two height options. The sturdy and flexible design is functional, practical and easy to use.



Dining Furniture

16 Seat Rectangular Mobile Folding Table

- Mobile folding table with grey frame which is easy to fold, store and clean
- Laminated table top with tough edging and MDF core (water resistant and easy clean)
- Fits through standard height doorway (1980mm) for storage and transportation
- Open position safety lock (to ensure table does not revert to folding position)
- Easy-clean intermediate lock for improved hygiene
- Transport and storage locking positions
- 16 year warranty on welds and mechanism
- Primary height 650mm
- Heavy duty locking castors
- 3 table top colours to choose from
- 11 stool colours to choose from
- FIRA certified



Rectangular Mobile Folding Table (16 Seat Unit)

650(h) x 3280(w) x 1500mm (d)



Table Top Colour Options * New colours available from January 2020

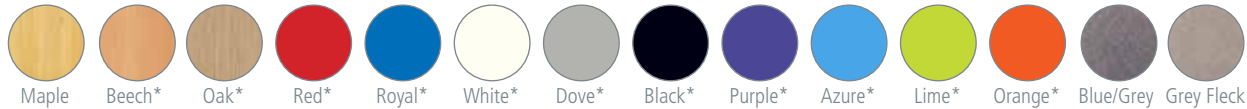

Stool Colour Options



Model Rectangular 1016

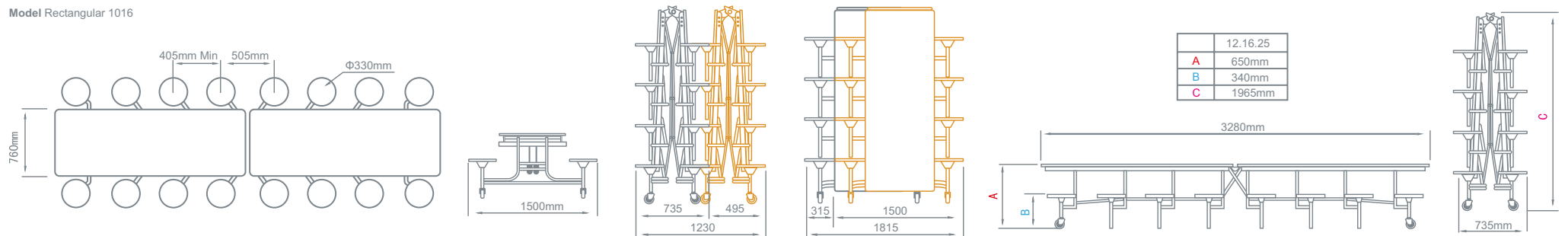

Functional

Designed specifically for primary use, the sixteen seat mobile folding unit is the ideal dining solution for younger children, not only is it easy to clean but when not in use, is easy to store too.



Dining Furniture

12 Seat SmartTop Mobile Folding Table

- Themed table tops designed to bring fun facts and increased awareness to the dining room
- Choose from 3 themes: World Geography, Modern History and Endangered Animals
- Laminated table top with tough edging and MDF core (water resistant and easy clean)
- Fits through standard height doorway (1980mm) for storage and transportation
- Open position safety lock (to ensure table does not revert to folding position)
- Easy-clean intermediate lock for improved hygiene
- Transport and storage locking positions
- Choice of two heights (primary and secondary)
- Heavy duty locking castors
- 11 stool colours to choose from
- FIRA certified
- 16 year warranty on welds and mechanism



World Map SmartTop

World Map SmartTop has a full sized map with country and city detail. The information around the map is split into continents with flags of each country that make up the continent plus country and city information. Each continent also has key information such as: area, total population, most populated city, population density per (km²), highest point, lowest point.

World Map SmartTop Table

685(h) x 3080(w) x 1500mm (d)

735(h) x 3080(w) x 1500mm (d)



Modern History SmartTop

Modern History SmartTop has information on significant world events, inventions, historical and sporting achievements in the decades from 1950 to 2000. Examples include: Discovery of DNA, the first scheduled flight by a commercial jet, first ascent of Mount Everest, first man to run a mile in under 4 minutes, the Cuban Missile Crisis and The Beatles first record.

Modern History SmartTop Table

685(h) x 3080(w) x 1500mm (d)

735(h) x 3080(w) x 1500mm (d)



Endangered Animals SmartTop

Endangered Animals SmartTop has information on the world's most at risk species including: tigers, rhinos, orangutans, elephants and Pandas. The SmartTop is full of useful "did you know?" information.

Endangered Animals SmartTop Table

685(h) x 3080(w) x 1500mm (d)

735(h) x 3080(w) x 1500mm (d)

Colour Options (Stools)



Model Rectangular 1012

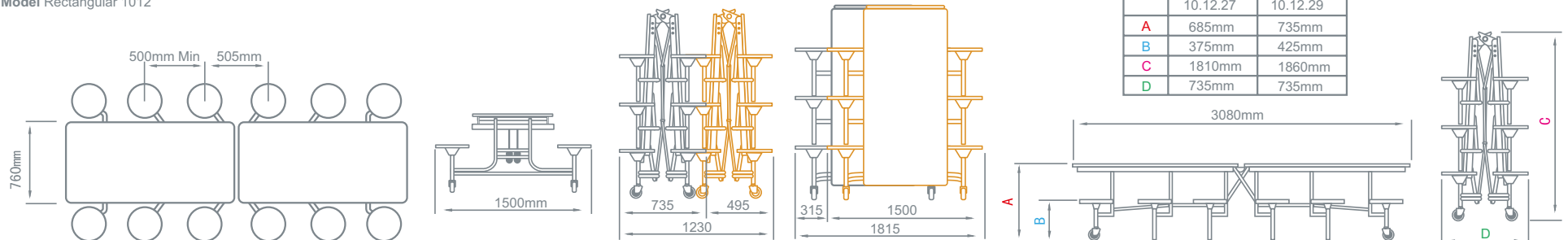

Educational

Graphically illustrated, our SmartTop tables contain fun facts on three separate subject areas which are designed to bring fun and increased awareness to the dining room. Choose from world map, modern history and endangered animals.



Dining Furniture

Convertible Bench Unit - 3 benches in 1

- Versatile bench unit perfect for auditorium and classroom seating
- Join two units together to create a configuration ideal for cafeteria/dining use
- Each bench seats between 4-6 children (depending on age)
- Laminated table top and bench with tough edging and MDF core (water resistant and easy clean)
- Choice of two heights (primary and secondary)
- Heavy duty locking castors
- 3 colours to choose from
- FIRA certified
- 16 year warranty on welds and mechanism



Convertible Bench Unit

685(h) x 2435(w) x 730mm (d)

735(h) x 2435(w) x 730mm (d)



Classroom Configuration



Auditorium Configuration

Table Top Colour Options * New colours available from January 2020

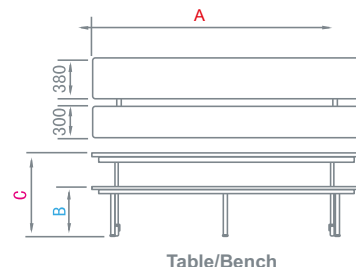
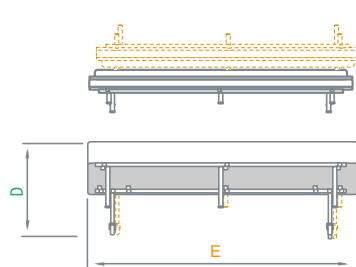
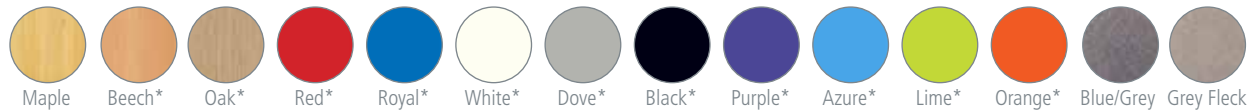

Table/Bench

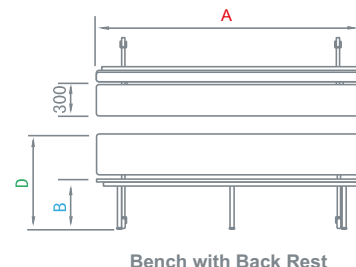

Bench with Back Rest

All sizes are in millimeters

	8ft - 27	8ft - 29
A	2435mm	2435mm
B	375mm	425mm
C	685mm	735mm
D	800mm	850mm
E	2485mm	2485mm

Convertible

Versatile in design, the bench unit is effectively three benches in one. Ideal for auditorium style seating, it can also be converted to a classroom table and then, by joining two units together, is perfect for dining use.



Cafeteria Configuration (when two units are joined)

Dining Furniture

Mobile Folding Bench Unit

- Mobile folding bench which seats between 12-16 children (depending on age)
- Easily accessible for children, through six obstacle free entrances
- Laminated table top and bench with tough edging and MDF core (water resistant and easy clean)
- Fits through standard height doorway (1980mm) for storage and transportation
- Open position safety lock (to ensure table does not revert to folding position)
- Easy-clean intermediate lock for improve hygiene
- Choice of two heights (primary and secondary)
- 16 year warranty on welds and mechanism
- Heavy duty locking castors
- 3 colours to choose from
- FIRA certified



Mobile Folding Bench

685(h) x 3080(w) x 1400mm (d)

735(h) x 3080(w) x 1400mm (d)

Table Top Colour Options * New colours available from January 2020

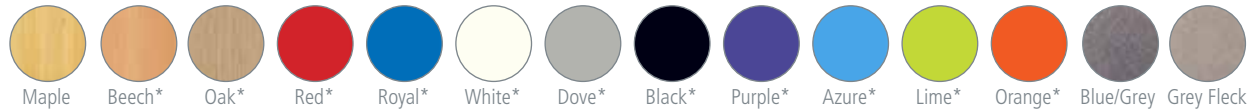

Model Folding Rectangular Bench Unit

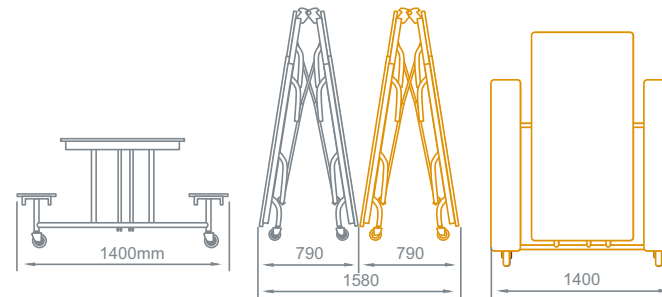
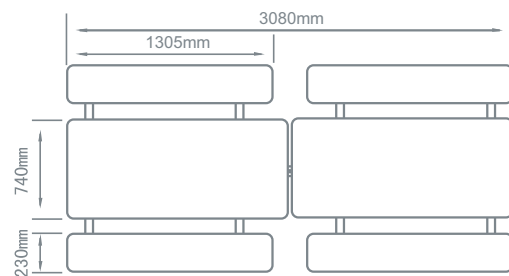

	27	29
A	685mm	735mm
B	375mm	425mm
C	1800mm	1850mm

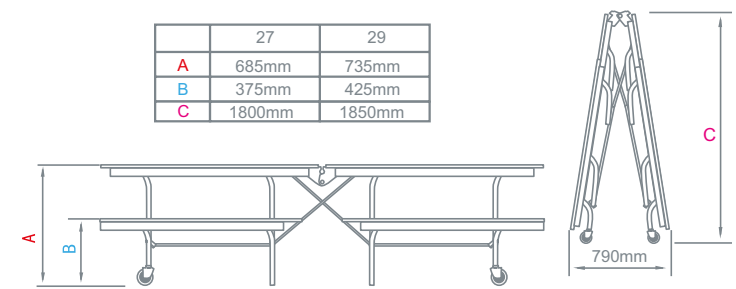

Accessible

The mobile folding bench is ideal for busy lunch times, and seats between twelve and sixteen children. This unit has the added benefit of being easily accessible through six obstacle free entrances.



Our Services

Site Survey (Free of charge service)

To help with the buying process, we would be delighted to arrange a free site survey. Your dedicated Account Manager will visit you to discuss your requirements and take the necessary measurements.

This information will then be discussed between your Account Manager and our Product Design Engineers to produce layout plans.

3D Space Planning (Free of charge service)

One of the most important services we provide to our customers is delivering detailed, aesthetic designs of cafeteria/dining room layouts.

To produce these, we employ qualified Product Design Engineers who are experts in creating bespoke dining solutions and space plans.

These designs are produced using modern 3D CAD (computer aided design) programmes to give a detailed idea of how the environment will look and feel. Using sophisticated modern 3D CAD engineering software, structural and finite element analysis is performed on all new designs to ensure that the most efficient and high performing solution is provided. These efforts result in high quality products at great value prices that our customers trust and that we are proud of.

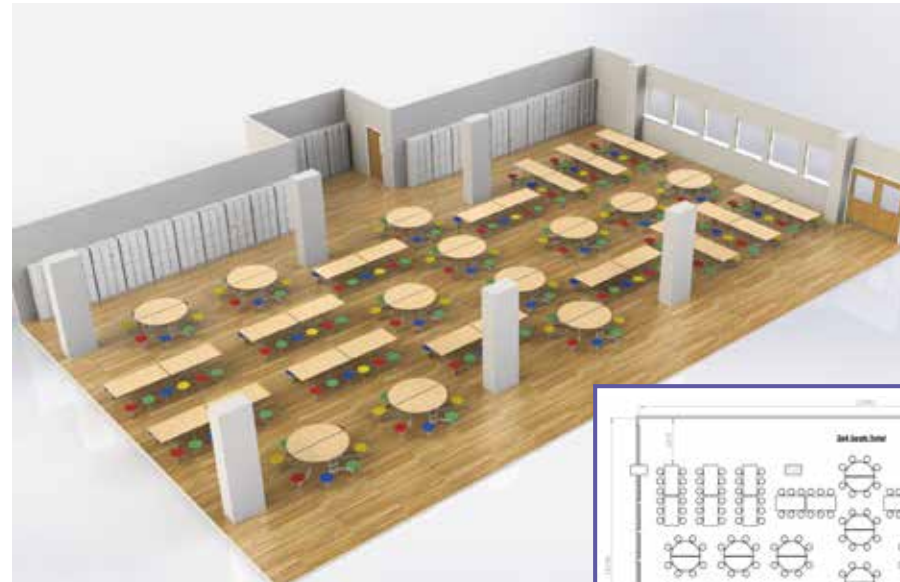

3D space plan for 14 x 12 seat rectangular and 12 x 8 seat round tables

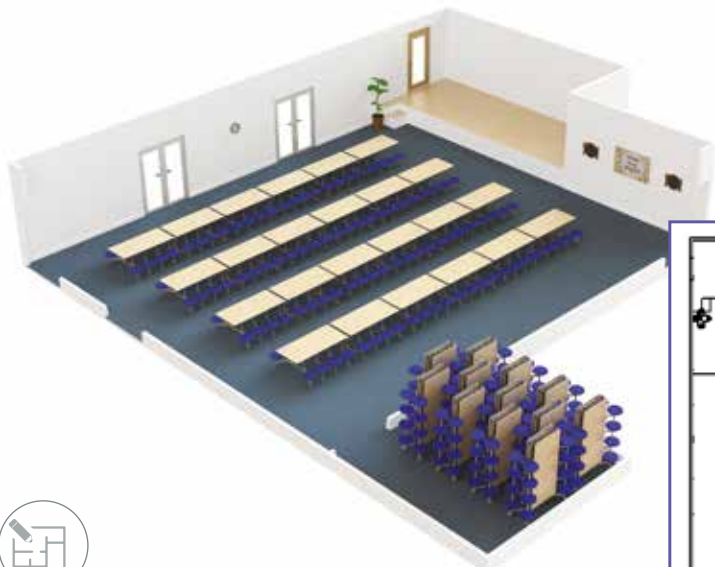
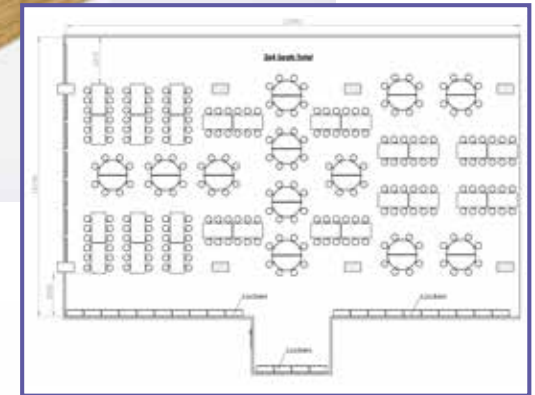

3D space plan for 12 x 12 seat rectangular tables

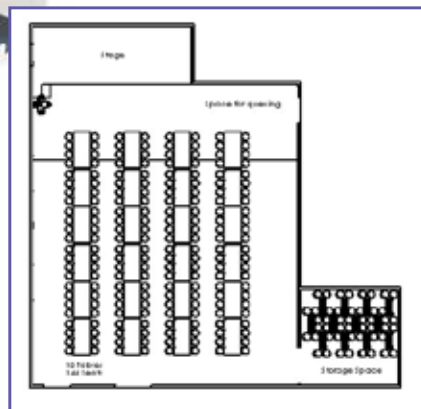

3D space plan for 14 x 8 seat round tables



Operating Instructions

Operating Instructions

In the interest of safety it is important that the operating instructions shown opposite are followed when deploying and storing the mobile folding tables.

Required Maintenance

To keep your tables operating to the optimum level, they must be checked on an ongoing basis as follows:

- Regularly inspect table operation for smoothness and general stability.
- Clean table tops according to current food service hygiene practices after each use. Exterior components of tables should be inspected for food deposits and cleaned as required. The underside of the tables should be inspected for chewing gum and other food deposits.
- Periodically you should lubricate tables with a food grade silicon spray, which is required to pivot joints. We recommend lubrication every six months or more often if indicated by stiff operation or noise.

CAUTION:- Excessive use of water during cleaning may cause corrosion



Folding Table Operating Instructions

Moving The Folding Table



With travel lock engaged push from the seats as shown.



Do **NOT** push the surface of the table.

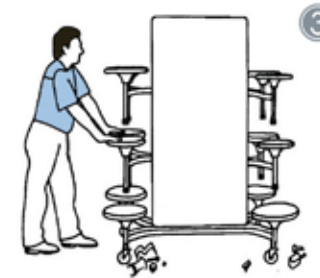

Avoid litter & obstacles on the floor.

Opening The Folding Table



With your left hand pushing down the travel lock, push apart the stool unit with your right hand on the middle stool.



Continue opening by pressing down with both hands on the middle stools.



Continue opening by pressing down with both hands on the centre stools.

Closing The Folding Table



Release locking bar by pressing down on the table surface, with right hand lift clear the lock.



Continue to lift using centre stools.



Using the middle stools push together to engage travel lock.

The logo for Spaceright Europe Ltd is a stylized circular emblem composed of several segments in shades of grey and orange. The word "SPACERIGHT" is written in a bold, sans-serif font, with "SPACE" in orange and "RIGHT" in grey. Below it, "europe ltd" is written in a smaller, lowercase, grey font.

SPACERIGHT
europe ltd

